

VOLL METAL SOLUTIONS

VOLL Metal Solutions

vollengineering.com

Protective Grating, Wire Bending, Welding,
powder coating



09/02/2025

CONTENTS

1. Who we are?
2. Wire Bending
3. Press Brake
4. Welding
5. Powder Coating





Who we are?

VOLL Engineering designs 2D – 3D Mold and Machine Technical drawings since 2015.

As VOLL Engineering, we care about continuity and quality in production.

In addition, we can produce precision measurements of parts during our manufacturing with our special equipment.

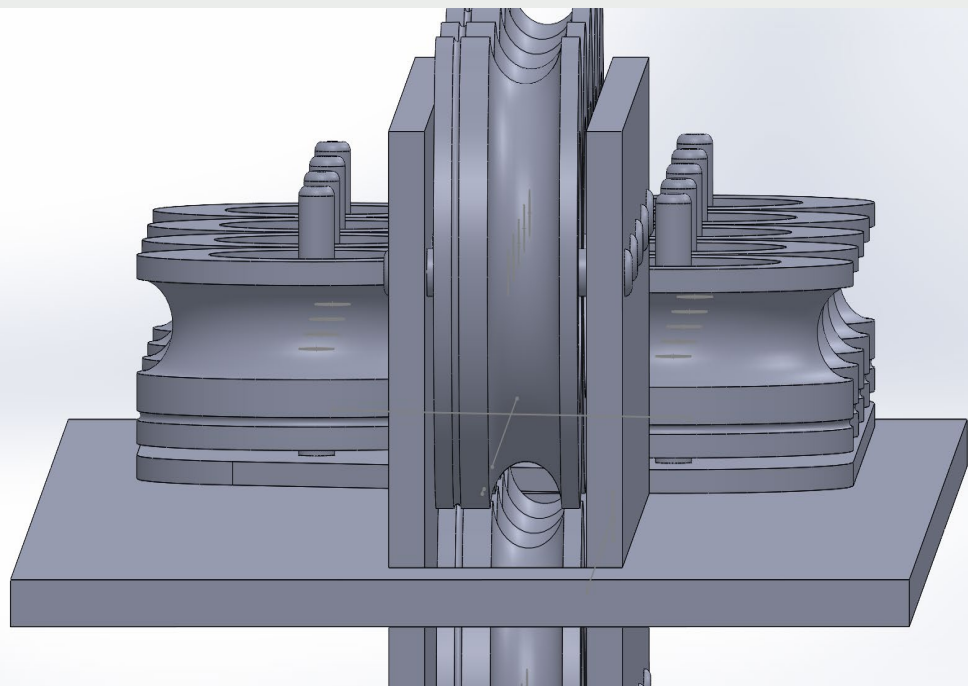



Manufacturing

Wire cut to size operation
with precision.

Manufacturing

We are manufacturing, bending, welding, painting 1-10mm steel wires.

Precisized Protective Grating Manufacturing is important for us.

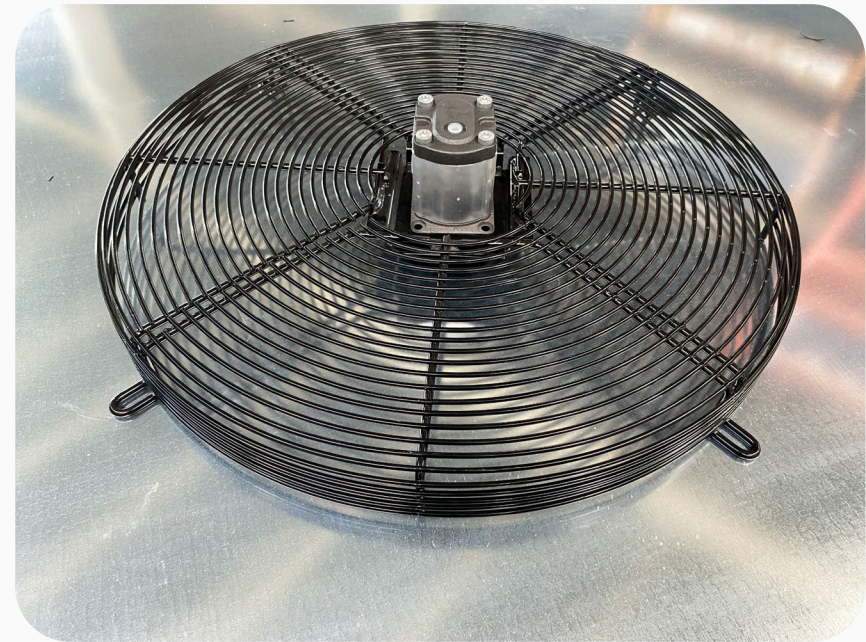

High Quality of Steel



VOLL Engineering *aiming always to provide its customers with the highest quality and the best service.*



A worldwide reliable partner in *wire bending, welding and painting.*

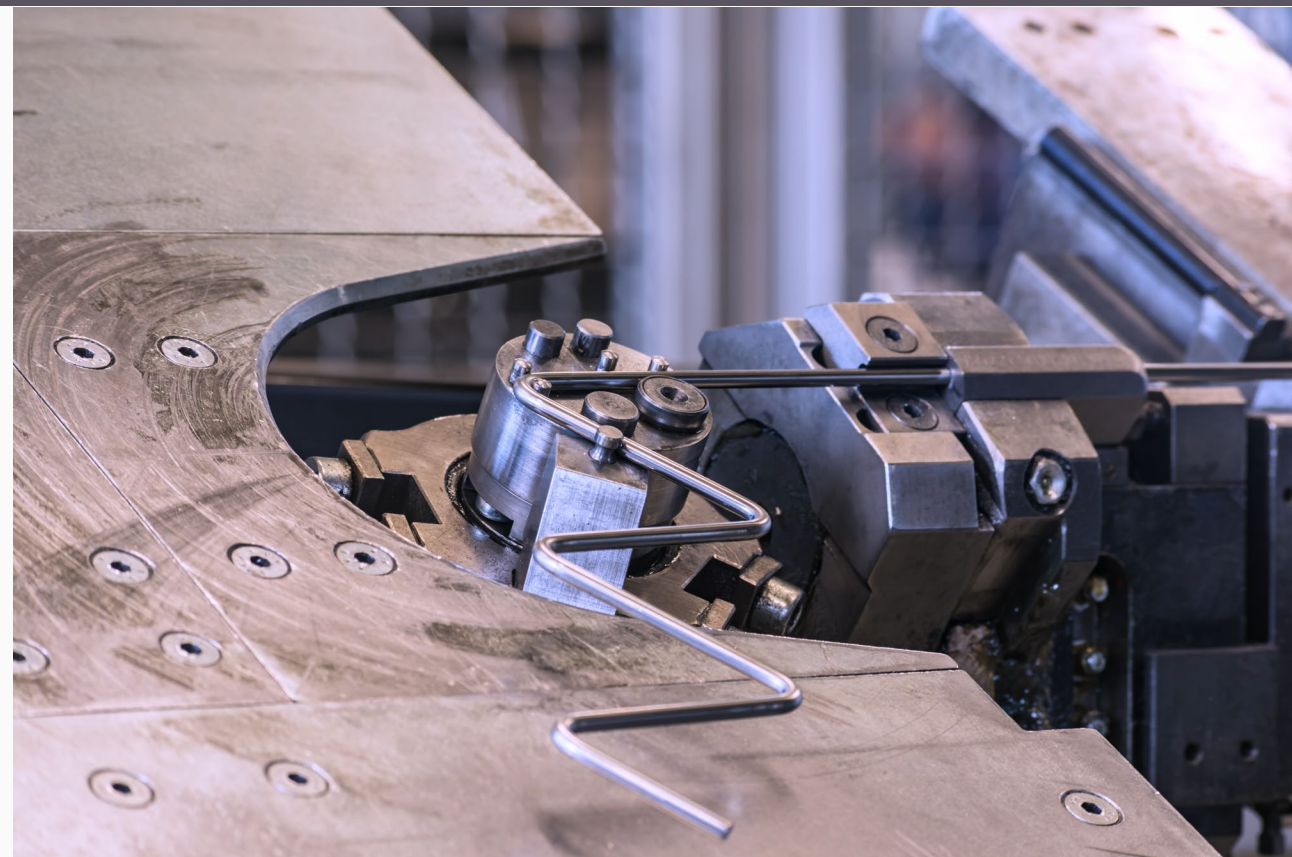

High Quality of Steel

IQM
Sertifika/Certificate

VOLL MÜHENDİSLİK TİCARET VE SANAYİ LİMİTED ŞİRKETİ
75.YIL MAH. 5339.SOK. NO:57A YUNUSEMRE/MANİSA

IQM Belgelendirme yukarıda bilgileri verilen kuruluşun **Çevre Yönetim Sistemini** değerlendirdiğini ve ilgili standardın gerekliliklerine uygun olduğunu onaylar.
IQM Certification confirms that the above-mentioned organization has evaluated the **Environment Management System** and that it complies with the requirements of the relevant standard.

ISO 14001:2015

Kapsam,
Scope,

METALLERİN MAKİNEDİ İŞLENMESİ VE KAYNAK İLE BİRLEŞTİRME FAALİYETLERİ
MACHINING METALS AND WELDING ACTIVITIES

Sertifika No/Certificate No	: IQM-E-1150
Sertifika İlk Yayın Tarihi/ Certificate Initial Issue Date	: 25.12.2023
Sertifika Yeniden Belgelendirme Tarihi/ Certificate Recertification Date	: -
Sertifika Yayın Tarihi/ Certificate Issue Date	: 02.12.2024
Sertifika Geçerlilik Tarihi/ Certificate Validity Date	: 24.12.2025

Bu sertifika IQM Belgelendirme kurallarına uyulmasını ve her yıl yapılacak gözetim denetimlerinin başarıyla gerçekleştirildiğini göstermektedir. Bu belge, ilgili standardın gerekliliklerine uygun olduğunu onaylar. Upon successful completion, the certificate is valid for three years from the date of first issue/recertification. The validity of the certificate is subject to an annual surveillance audit. The validity status of the certificate can be checked at <https://tds.turkac.org.tr>.

GENEL MÜDÜR
GENERAL MANAGER

IQM Uluslararası Belgelendirme (Eğitim ve Gözetim Hizmetleri) Ltd. Şti.
 İşyeri: 75.Yıl Mah. 5339.Sok. No:57A Yunus Emre / Manisa
 Tel: 0232 574 54 77 Faks: 0232 574 574 78 E-Posta: info@iqm.com.tr www.iqm.com.tr
 FR_23_07_06_2024/ Rev. No: 07 Rev. Tari: 26.02.2024

IQM
Sertifika/Certificate

VOLL MÜHENDİSLİK TİCARET VE SANAYİ LİMİTED ŞİRKETİ
75.YIL MAH. 5339.SOK. NO:57A YUNUSEMRE/MANİSA

IQM Belgelendirme yukarıda bilgileri verilen kuruluşun **Kalite Yönetim Sistemini** değerlendirdiğini ve ilgili standardın gerekliliklerine uygun olduğunu onaylar.
IQM Certification confirms that the above-mentioned organization has evaluated the **Quality Management System** and that it complies with the requirements of the relevant standard.

ISO 9001:2015

Kapsam,
Scope,

METALLERİN MAKİNEDİ İŞLENMESİ VE KAYNAK İLE BİRLEŞTİRME FAALİYETLERİ
MACHINING METALS AND WELDING ACTIVITIES

Sertifika No/Certificate No	: IQM-Q-1150
Sertifika İlk Yayın Tarihi/ Certificate Initial Issue Date	: 25.12.2023
Sertifika Yeniden Belgelendirme Tarihi/ Certificate Recertification Date	: -
Sertifika Yayın Tarihi/ Certificate Issue Date	: 02.12.2024
Sertifika Geçerlilik Tarihi/ Certificate Validity Date	: 24.12.2025

Bu sertifika IQM Belgelendirme kurallarına uyulmasını ve her yıl yapılacak gözetim denetimlerinin başarıyla gerçekleştirildiğini göstermektedir. Bu belge, ilgili standardın gerekliliklerine uygun olduğunu onaylar. Upon successful completion, the certificate is valid for three years from the date of first issue/recertification. The validity of the certificate is subject to an annual surveillance audit. The validity status of the certificate can be checked at <https://tds.turkac.org.tr>.

GENEL MÜDÜR
GENERAL MANAGER

IQM Uluslararası Belgelendirme (Eğitim ve Gözetim Hizmetleri) Ltd. Şti.
 İşyeri: 75.Yıl Mah. 5339.Sok. No:57A Yunus Emre / Manisa
 Tel: 0232 574 54 77 Faks: 0232 574 574 78 E-Posta: info@iqm.com.tr www.iqm.com.tr
 FR_23_07_06_2024/ Rev. No: 07 Rev. Tari: 26.02.2024

IQM
Sertifika/Certificate

VOLL MÜHENDİSLİK TİCARET VE SANAYİ LİMİTED ŞİRKETİ
75.YIL MAH. 5339.SOK. NO:57A YUNUSEMRE/MANİSA

IQM Belgelendirme yukarıda bilgileri verilen kuruluşun **İş Sağlığı ve Güvenliği Yönetim Sistemini** değerlendirdiğini ve ilgili standardın gerekliliklerine uygun olduğunu onaylar.
IQM Certification confirms that the above-mentioned organization has evaluated the **Occupational Health and Safety Management System** and that it complies with the requirements of the relevant standard.

ISO 45001:2018

Kapsam,
Scope,

METALLERİN MAKİNEDİ İŞLENMESİ VE KAYNAK İLE BİRLEŞTİRME FAALİYETLERİ
MACHINING METALS AND WELDING ACTIVITIES

Sertifika No/Certificate No	: IQM-S-1150
Sertifika İlk Yayın Tarihi/ Certificate Initial Issue Date	: 25.12.2023
Sertifika Yeniden Belgelendirme Tarihi/ Certificate Recertification Date	: -
Sertifika Yayın Tarihi/ Certificate Issue Date	: 02.12.2024
Sertifika Geçerlilik Tarihi/ Certificate Validity Date	: 24.12.2025

Bu sertifika IQM Belgelendirme kurallarına uyulmasını ve her yıl yapılacak gözetim denetimlerinin başarıyla gerçekleştirildiğini göstermektedir. Bu belge, ilgili standardın gerekliliklerine uygun olduğunu onaylar. Upon successful completion, the certificate is valid for three years from the date of first issue/recertification. The validity of the certificate is subject to an annual surveillance audit. The validity status of the certificate can be checked at <https://tds.turkac.org.tr>.

GENEL MÜDÜR
GENERAL MANAGER

IQM Uluslararası Belgelendirme (Eğitim ve Gözetim Hizmetleri) Ltd. Şti.
 İşyeri: 75.Yıl Mah. 5339.Sok. No:57A Yunus Emre / Manisa
 Tel: 0232 574 54 77 Faks: 0232 574 574 78 E-Posta: info@iqm.com.tr www.iqm.com.tr
 FR_23_07_06_2024/ Rev. No: 07 Rev. Tari: 26.02.2024

Protective Fan Guards

As you see, this Protective Grating is not just 1 part. This is 2 part. We can develop our manufacturing capacity for your projects.

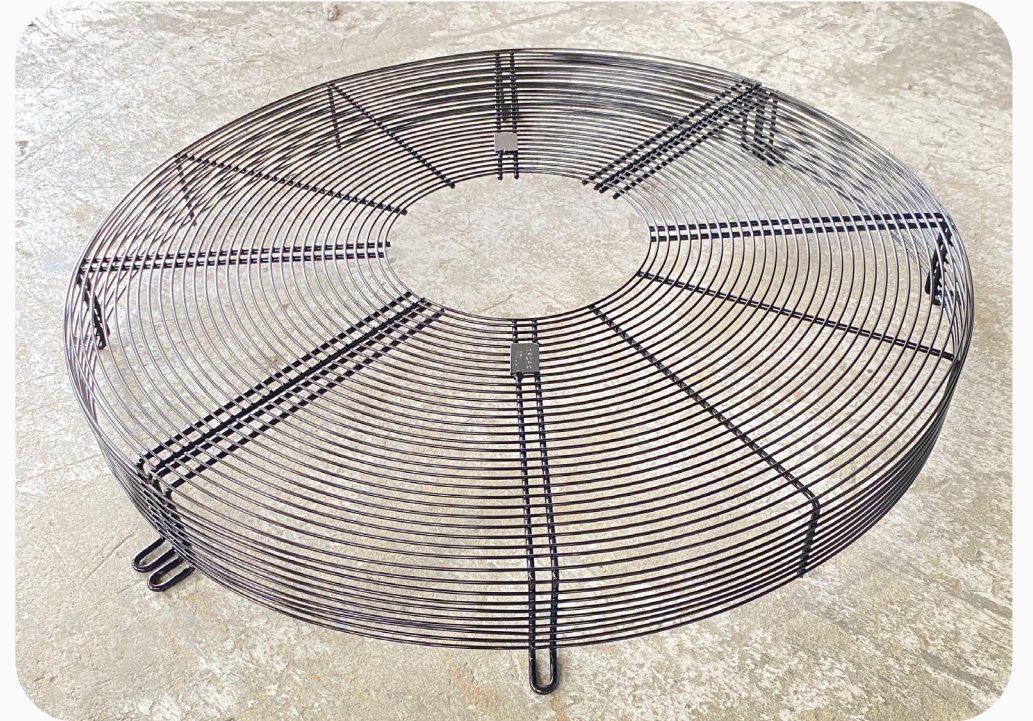

Protective Fan Guards

No limit for diameter of Protective Grating.

We provide best deadline date.

VOLL Metal Solutions is the best choice for your Quality Team.



Protective Fan Guards

We are designing precisized molds for special designs. We have no limit for manufacturing skills.



Protective Fan Guards

Our team precisized manufactured this Protective Grating(R72)

Specificated flange easy for our manufacturing line.



Protective Fan Guards



Our team precisized manufactured this Protective Grating

Specificated flange easy for our manufacturing line.

Protective Fan Guards



09/02/2025

13

Protective Fan Guards

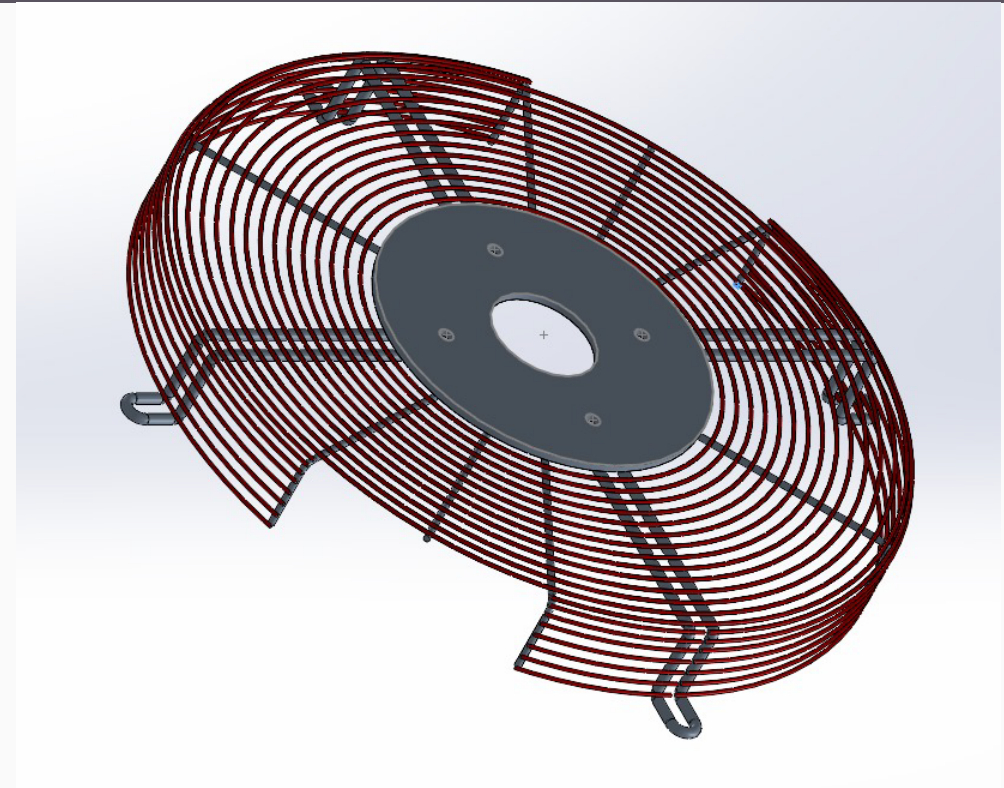

Protective Fan Guards



Protective Fan Guards

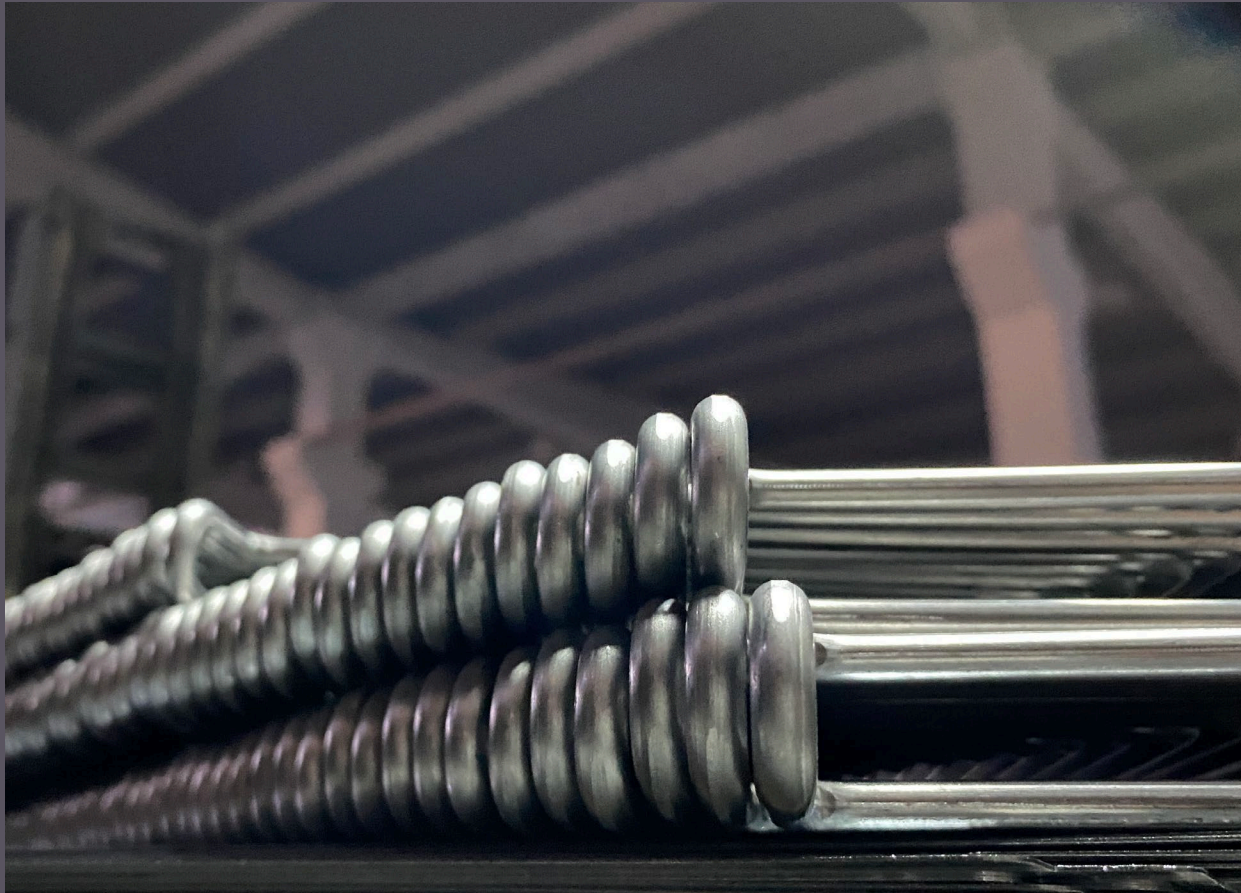

09/02/2025

16



WELDING TECHNOLOGIES

VOLL Engineering



LASER CUTTING

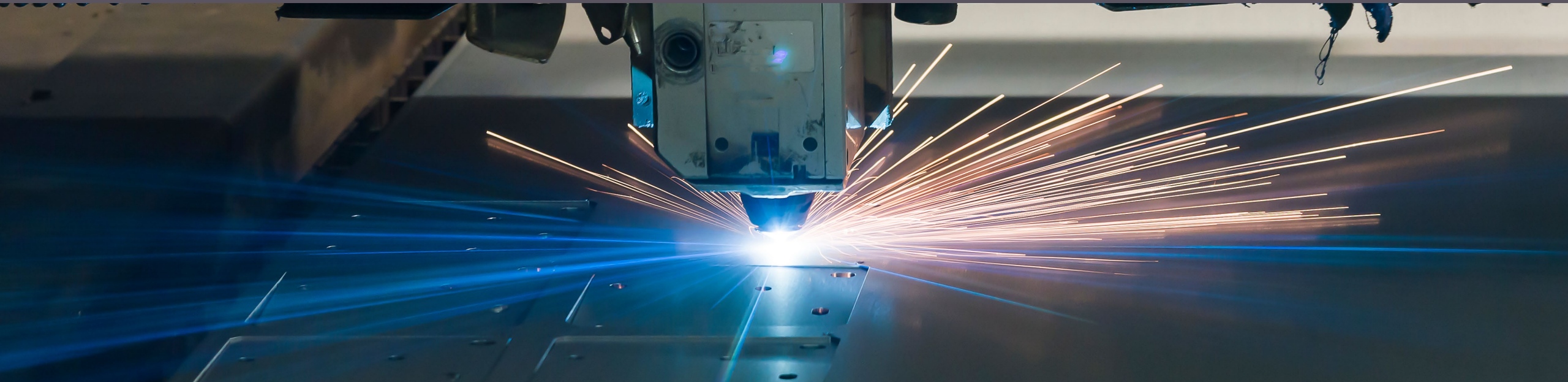

CAPACITY

*You can trust manufacturing quality of our machines. Because meaning of **VOLL** comes from the **vollständig** in German.*

This means completed perfect, full.

LASER CUTTING

CAPACITY

We can provide 0.1mm to 15mm sheet metal. Our Protective Grating's Flanges manufacturing by our team.



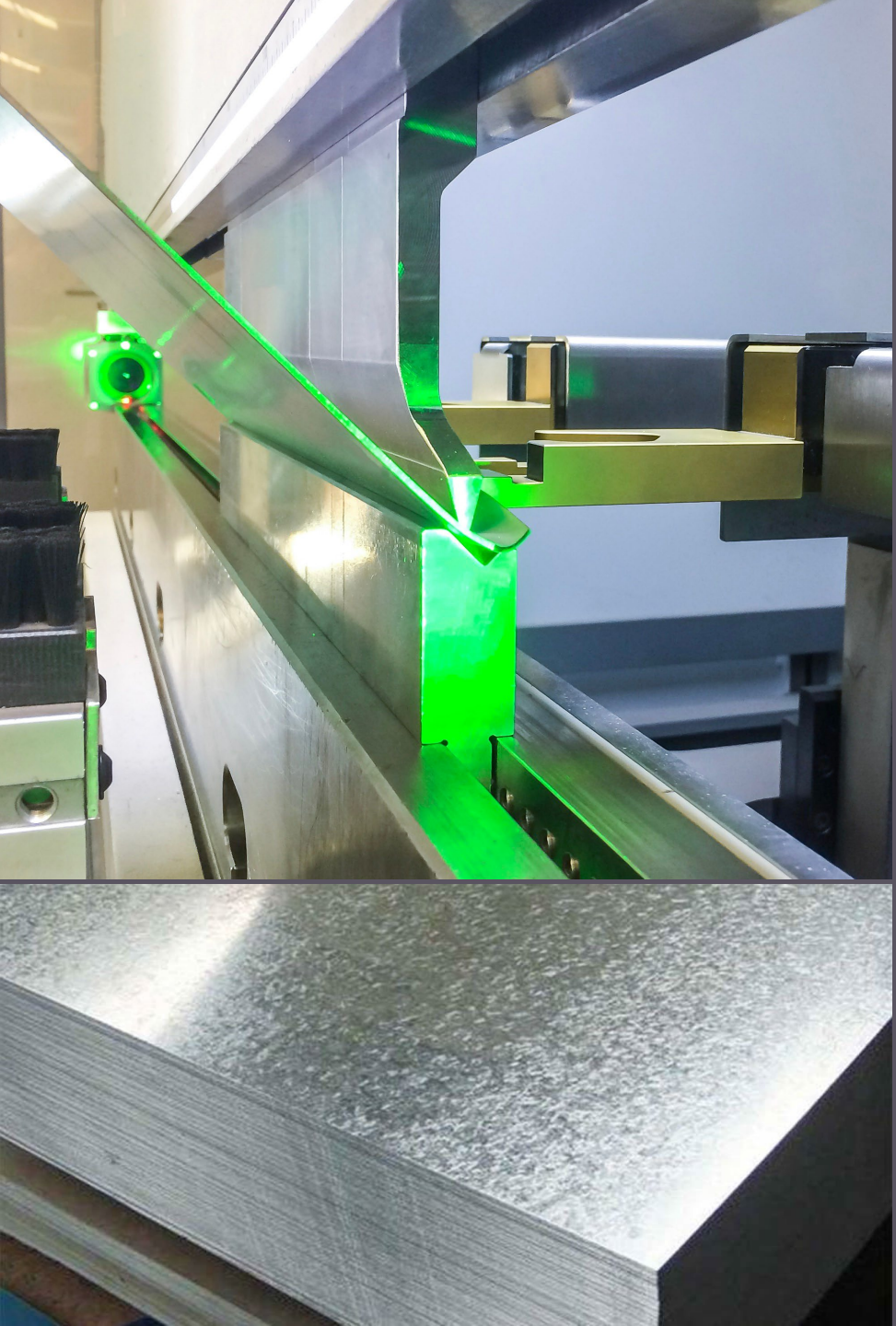

PRESS BRAKE

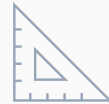

We capture precise measurements with our quality sheet metals and special measuring tools.



Precision machine support up to 2.5 meters wide.



Custom mold support. We can reach the fillet you want. Speciflicated Motor Flanges which used in Protective Gratings, we manufactured.



At what stage is the production? You can reach our teammates in our Website or by phone.



CAPACITY

We can provide electrostatic powder paint application with all of RAL Color codes.

PAINTING

SAMPLES

You can reach us then get your sample for our manufacturing quality.





SAFE TRANSPORTATION IS IMPORTANT

We Provide specificated shock absorbing cardboard box for our Protective Gratings.

LOGISTICS



Respect for our Environment

shows the utmost respect for the environment at its wire bending, sheet metal bending and welding complying with all regulations.



Customer Satisfaction

Approaching our customers with a full understanding of their needs

Supplying our customers with the best available quality products

Always maintaining our stance as a reliable and dependable supplier

Developing long-lasting relations with our customers for our mutual benefit

Always accessible, easy to work with

Respect

CONTACT



VOLL Metal Solutions
VOLL Mühendislik Sanayi ve Ticaret
Limited Şirketi



vollengineering.com



voll.engineering@gmail.com



Muradiye mahallesi 18. Sokak
Yunusemre / Manisa / Turkey

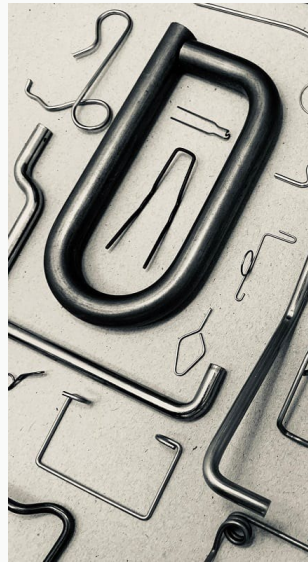

09/02/2025

25